



# HISTORIC SPORTS CAR CLUB

*Established 1966*

Silverstone Circuit, Silverstone, TOWCESTER, Northants NN12 8TN

Telephone: +44 (0) 1327-858400 : Facsimile: +44 (0) 1327-858500

E-mail: office@hsccl.org.uk : www.hsccl.org.uk

Historic Sports Car Club Ltd - A company limited by guarantee - Registered in England - 04448259

## HSCC Historic Formula 3 Championship Regulations 2022

### Eligible Cars:

The HSCC Historic Formula 3 championship is open to cars currently running to a configuration in which that individual chassis competed with between January 1st 1964 and December 31st 1970 compliant with International FIA F3 regulations for that period. This will include cars that competed in the Temporada Series which took place at Interlagos 10/1/1971, 17/1/1971, 25/1/1971 and Taruma 1/02/1971 under FIA (1964 - 1970) Formula 3 regulations. No cars may use wings or aerodynamic aids.

All cars must have current FIA or HSCC Vehicle Identification Forms.

### Class Structure - Historic Formula 3 Championship

Class A - Cars which competed between 1/01/64 - 31/12/65 with one litre engines fitted with side draught cylinder heads and carburettors. Other side draught cars which in the opinion of the 1KF3HRA were one offs which were predominantly constructed before end of 1966 may be permitted to Run in Class A subject to Class A technical regulations.

Class B - Cars which competed between 01/01/66 and 31/12/70 with one litre engines, this includes the following:

Cars built prior to 31/12/1965 fitted with wider wheels and tyres as per Class B Technical regulations.

All cars with provenance of competing with a downdraught cylinder head prior to 31/12/1970 or in the 1971 Temporada Series can/will run as such in Class B

Class I - Invitation Class for Historic F3 cars built between 1964 and 1970 also cars complying only with Historic F3 1000cc European Trophy Regulations. 1000cc F2 cars built and raced between 01/01/1964 & 31/12/1966 Compliant with International FIA F2 regulations for that period.

### 1. SPORTING REGULATIONS - GENERAL

#### 1.1 Title and Jurisdiction:

The HSCC Historic Formula 3 Championship is organised and administered by the Historic Sports Car Club [HSCC] in accordance with the General Regulations of the Royal Automobile Club Motor Sports Association [Motorsport UK] (incorporating the provisions of the International Sporting Code of the FIA).

Motorsport UK **Championship Permit No:** (TBC)

**Race Status:** Interclub

Motorsport UK **Championship Grade:** D

#### 1.2 Officials:

1.2.1 Co-ordinator: Mr A. Dee-Crowne, HSCC, Silverstone Circuit, Silverstone, Nr. Towcester, Northants NN12 8TN. Tel. 01327 858400.

1.2.2 Eligibility Scrutineer: Nigel Edwards, Greenleaves, Fern Road, Storrington, West Sussex, RH20 4LW

1.2.3 Championship Stewards: Mr. Chris Alford, Mr Charles Barter, Mr Peter Wray  
All C/O HSCC, Silverstone Circuit, Nr. Towcester, Northants, NN12 8TN

**DRAFT COPY**

### 1.3 Competitor Eligibility:

#### 1.3.1 Entrants must:

- (a) be fully paid-up members of the HSCC and
- (b) in possession of a valid 2022 Motorsport UK Entrant's Licence.

#### 1.3.2 Drivers and Entrant/Drivers must:

- (a) be fully paid-up members of the HSCC and,
- (b) be registered for the Championship and
- (c) be in possession of a valid 2022 Motorsport UK Competition (Racing) Interclub status licence as a minimum. For any championship rounds held outside of the UK all drivers will require a National status licence minimum. (Q 11.6.)
- (d) \*Or be in possession of the highest grade of national Race license or valid FIA International License, together with their ASN's written consent ((H)25.2.1 and FIA ISC Article 2.3.7.b applies)

#### 1.3.3 All necessary documentation, including FIA Identity documents, must be presented for checking at all rounds when signing-on.

### 1.4 Registration:

1.4.1 All drivers must register as competitors for the Championship by returning the registration form with the registration fee to the HSCC prior to the final Closing date for the first race being entered.

1.4.2 The registration fee is £210 to include membership of the HSCC. Cheques made payable to the HSCC. All drivers and Entrant Drivers must also be members of the 1000cc F3 Historic Racing Association to be registered for the Championship.

1.4.3 Registrations will be accepted from 1<sup>st</sup> January 2022.

1.4.4 Registration numbers will be the permanent Competition numbers for the Series.

### 1.5 Championship Events:

The HSCC Formula 3 Championship will be contested at X race meetings.

| Date | Circuit | Status | Org. Club |
|------|---------|--------|-----------|
|      |         |        |           |
|      |         |        |           |
|      |         |        |           |
|      |         |        |           |
|      |         |        |           |
|      |         |        |           |
|      |         |        |           |

### 1.6 Scoring:

#### 1.6.1 Points

**Points** will be awarded to Competitors listed as classified finishers (to be classified as a finisher, a car must cross the finish line after the winner does, or take the chequered flag in the pit lane) in the Final Results as follows:-

|                  |    |                  |    |
|------------------|----|------------------|----|
| <b>Position</b>  |    | 17 <sup>th</sup> | 19 |
| 1 <sup>st</sup>  | 45 | 18 <sup>th</sup> | 18 |
| 2 <sup>nd</sup>  | 40 | <b>Position</b>  |    |
| 3 <sup>rd</sup>  | 37 | 19 <sup>th</sup> | 17 |
| 4 <sup>th</sup>  | 35 | 20 <sup>th</sup> | 16 |
| 5 <sup>th</sup>  | 33 | 21 <sup>st</sup> | 15 |
| 6 <sup>th</sup>  | 31 | 22 <sup>nd</sup> | 14 |
| 7 <sup>th</sup>  | 29 | 23 <sup>rd</sup> | 13 |
| 8 <sup>th</sup>  | 28 | 24 <sup>th</sup> | 12 |
| 9 <sup>th</sup>  | 27 | 25 <sup>th</sup> | 11 |
| 10 <sup>th</sup> | 26 | 26 <sup>th</sup> | 10 |
| 11 <sup>th</sup> | 25 | 27 <sup>th</sup> | 9  |
| 12 <sup>th</sup> | 24 | 28 <sup>th</sup> | 8  |
| 13 <sup>th</sup> | 23 | 29 <sup>th</sup> | 7  |
| 14 <sup>th</sup> | 22 | 30 <sup>th</sup> | 6  |
| 15 <sup>th</sup> | 21 | 31 <sup>st</sup> | 5  |
| 16 <sup>th</sup> | 20 |                  |    |

|                  |   |                  |   |
|------------------|---|------------------|---|
| 32 <sup>nd</sup> | 4 | 34 <sup>th</sup> | 2 |
| 33 <sup>rd</sup> | 3 | 35 <sup>th</sup> | 1 |

- 1.6.2 The totals from all qualifying rounds less 2 (excluding any races which are abandoned and not replaced) will determine the final championship points and positions.
- 1.6.3 Ties shall be resolved using the formula in Section **W1.3.4** in the current Motorsport UK Yearbook
- 1.6.4 Where the race distance has been reduced (2.6) it shall still count as a full points-scoring round.
- 1.6.5 Competitors not registered for the Championship may be permitted on an individual round basis and will:
- be deemed "Guest Competitors"
  - not score points and for the purpose of points scoring will be ignored
  - qualify for Event awards
  - comply with the eligibility criteria as prescribed in Article 1.3 above, with the exception of 1.3.1(b) and 1.3.2 (b), as appropriate.

## **1.7 Awards:**

- 1.7.1 All awards are to be provided by the race organisers.
- 1.7.2 Per round: : A trophy to the overall winner, second overall and third overall also trophies to first and second in class A subject to five starters in class. Trophies to first in class A will be awarded subject to three starters in class. Class I does not qualify for overall positions or trophies. *Historic F2 cars may be eligible for individual Historic F2 awards but are not eligible for any trophies or laurels for the outright wins*
- 1.7.3 Championship: Championship winner and 2<sup>nd</sup> - 6<sup>th</sup> overall will each receive a Trophy. The highest placed finisher in Each Class (including Class B) will each receive a trophy, the 2<sup>nd</sup> subject to 6 in class and 3<sup>rd</sup> subject to more than 6 in class will receive a trophy. To qualify for an award a competitor must have competed in at least 4 rounds. Other awards may be given at the Championship Organisers' discretion.
- 1.7.4 **Presentations:** Winners' trophies are to be provided for presentation at the end of each race or at the end of the meeting presentation ceremony. Class trophies will be available from the paddock office one hour after the official results have been published.
- 1.7.5 **Entertainment Tax Liability:**  
Prize Money and Bonuses not applicable.  
In accordance with current government legislation, the HSCC is legally obliged to withhold tax at the basic rate on all payments to non-UK resident sportsmen/women and account to HMRC using form FEU1, the quarterly return of payments made to non-resident entertainers and sportsmen/women.  
That is those persons who do not have a normal permanent residence in the UK. The UK does not include the Isle of Man, Channel Isles or Eire. This means that, as the organiser, the HSCC is required to deduct tax at the current rate applicable from any such payments they may make to non-UK residents.  
Under certain circumstances, it may be possible for competitors to enter into an agreement with the Inland Revenue to limit tax withheld. Any application for such an arrangement must be made in writing and not later than 30 days before the payment is due.  
For further information contact:- HMRC Personal Tax International, Foreign Entertainers Unit, St John's House, Merton Road, Liverpool. L75 1BB. Tel: 0151 472 6488 Fax: 0151 472 6483
- 1.7.6 **Title to all trophies:** In the event of any Provisional Results or Championship Tables being revised after any provisional presentations and such revisions affect the distribution of any awards, the Competitors concerned must return such awards to the HSCC in good condition within 7 days.

## 2. CHAMPIONSHIP EVENT MEETINGS & RACE PROCEDURES

All competitors are reminded that they are racing Historic Cars, which by their nature are expensive and difficult to repair, they are part of our sporting heritage. Parts often have to be manufactured as they are not available 'off the shelf'. These cars require respect as do your fellow competitors. You will be expected to race within those parameters. If you are involved in an incident you will be required to report your actions to the Clerk of the Course if called.

### 2.1 Entries:

- 2.1.1 Competitors are responsible for sending in correct and complete entries with the correct entry fee prior to the closing date for entries before each event.
- 2.1.2 Incorrect or incomplete entries (including Driver to be Nominated Entries) are to be held in abeyance until they are complete and correct and the date of receipt for acceptance of entry purposes shall be the date on which the Secretary of the Meeting receives the missing or corrected information or fee.
- 2.1.3 Any withdrawal of Entry or Driver/Car changes made after acceptance of any entry must be notified to the Meeting Organisers in writing D25.1.12 applies.
- 2.1.4 The Entry Fee for each event shall be specified in the SRs and on the entry form.
- 2.1.5 Reserves will be listed in the Final List of Entries published with Final Instructions or in a Bulletin.

### 2.2 Briefings:

Organisers should notify Competitors of the times and locations for all briefings in the Final Instructions for the meetings. Competitors must attend all briefings.

### 2.3 Qualification Practice:

- 2.3.1 Should any Practice Session be disrupted, the Clerk of the Course shall not be obliged to resume the session or re-run sessions to achieve the championship criteria and the decision of the Clerk of the Course shall be final.
- 2.3.2 Any driver who has not raced on the course in its current layout within the preceding twelve months must complete a minimum of 3 laps in the car to be raced, and in the correct session, in order to qualify (Motorsport UK Regulation Q12.9.7).
- 2.3.3 If there is more than one race at a race meeting, then the times from practice session one will establish the grid for race one. The grid for race two will be formed from the drivers' fastest lap times in race one.
- 2.3.4 As a specific exception to 2.3.3, for races combined with another Championship/Series all participants will start the first race in order of their overall qualifying performance. Starting positions for race 2 will be decided by the rules for whichever Championship/Series had the majority of starters in qualifying.

### 2.4 Races:

Should any race be disrupted the Clerk of the Course shall not be obliged to resume or rerun the race Q5.4 (1.6.4. above applies)

### 2.5 Starts:

- 2.5.1 All cars will be released to form up on the grid prior to the start in formation as specified on the grid sheet.
- 2.5.2 The start will be via a Standing start  
The minimum Countdown procedures/audible warning sequence shall be:-
  - I. 1 minute to start of Green Flag/Pace Lap - Start Engines/Clear Grid
  - II. 30 Seconds - Visible and audible warning for start of Green Flag/Pace Lap.
  - III. A five second board will be used to indicate that the grid is complete.
  - IV. The red lights will be switched on five seconds after the board is withdrawn.
- 2.5.3 Any cars removed from the grid after the one minute stage or driven into pits on Green Flag Lap shall be held in the pit lane and may start the race after the last car has passed the startline or pit lane exit, whichever is the later.
- 2.5.4 Any driver unable to start the Green Flag/Pace Lap or start is required to indicate their situation as per Motorsport UK Regulation Q12.11.1. In addition, any driver unable to maintain grid positions on Green Flag Lap, to the extent that ALL other cars are ahead of them, may complete the green flag lap but MUST remain at the rear of the last row of the grid but ahead of any cars to be started with a time delay.
- 2.5.5 In the event of any starting lights failure the Starter will revert to use of the National

Flag.

2.5.6 Should circumstances at the event change such as, but not restricted to, Track Conditions or Weather, the Clerk of the Course may change Standing Starts to Rolling Starts. When this decision is made all affected competitors will be notified at the earliest opportunity along with being advised of the number of Pace laps.

#### 2.6.1 **SESSION RED FLAG**

Should the need arise to stop any race or practice, RED LIGHTS will be switched on at the Startline and RED FLAGS will be displayed at the Startline and at all Marshals' Signalling Points around the circuit. This is the signal for all drivers to cease circulating at racing speeds, to slow to a safe and reasonable pace and to return to the pit lane, during practice, and to the starting grid area, during a race, unless otherwise directed by officials. Cars may not enter the Pits unless directed to do so. Work on cars already in the pits must cease when a race is stopped.

#### 2.7 **Pits, Paddock & Pit Lane Safety:**

2.7.1 **Pits & Paddock:** Competitors must ensure that the Motorsport UK, Circuit Management and Organising Club Safety regulations are complied with at all times.

2.7.2 **Pit Lane:** The outer lane or lanes are to be kept unobstructed to allow safe passage of cars, the onus shall be on all drivers to take all due care and respect the pit lane speed limits.

2.7.3 **Refuelling:** May only be carried out in accordance with the Motorsport UK Q12.25.1 - Q12.25.4 Regulations, Circuit Management Regulations and the Supplementary Regulations or Final Instructions issued for each Circuit/Meeting.2.7.4

2.7.4 **Speed Limit:** Pit Lane Speed Limit will be 60 Km/h (37.2Mph)

#### 2.8 **Race Finishes:**

Cars may either cross the Finishing Line or take the chequered flag in the pit lane in the interests of safety, or where a back marker has been overtaken on the winner's slowing down lap and subsequently flagged off by marshals. At circuits where such use of the pit lane represents an advantage, in terms of circuit length or speed, an appropriate time penalty will be added to the driver's race time.

After taking the Chequered Flag drivers are required to:

- I. progressively and safely slow down,
- II. remain behind any competitors ahead of them,
- III. return to the Pit Lane Entrance/Paddock Entrance as instructed,
- IV. comply with any directions given by Marshals or Officials
- V. keep helmets on and harnesses done up while on the circuits or in the pitlane.

#### 2.9 **Results**

All Practice Timesheets, Grids, Race Results are to be deemed PROVISIONAL until all vehicles are released by Scrutineers after Post Practice/Race Scrutineering and/or after completion of any Judicial or Technical Procedures (Motorsport UK regulation D26.3).

#### 2.10 **Timing Modules:**

All cars must be fitted with a working HSCC approved transponder. Failure may result in competitors not being accredited with a qualifying time or excluded from the result as per Motorsport UK regulation Q12.8.1

2.11 **Qualification Races:** -If any event is oversubscribed the Organising Club may at their discretion run Qualification Races.

2.12 **Operation of Safety Car:** *The safety car will be brought into operation and run in accordance with Section Q, Appendix 2 of the Motorsport UK General Regulations.*

#### 2.13 **Onboard Cameras**

The use of onboard cameras is permitted, but they must be fitted and declared at scrutineering for examination. Upon request any onboard footage must be made available to Clerk of the Course and or Stewards in the event of an incident, during the event.

##### 2.13.1 **Data Logging**

The use of data loggers that record Data for post-race analysis is accepted. The use of linked data performance loggers that supply real time information in cockpit is not permitted

### **3. SPECIFIC CHAMPIONSHIP REGULATIONS**

Nil

### **4. SPECIFIC CHAMPIONSHIP PENALTIES:**

In accordance with Section C of the current Motorsport UK Yearbook.

#### **4.1 Infringements of Technical Regulations:**

4.1.1 Arising from post practice Scrutineering or Judicial Action: Minimum penalty: The provisions of Motorsport UK regulations: (C3.3.).

4.1.2 Arising from post race Scrutineering or judicial action: Minimum penalty: The provisions of Motorsport UK regulations: C3.5.1(a) & (b).

For infringements deemed to be of a more serious nature the Clerk of the Course will invoke the provisions of Regulation C3.5.1(c).

4.2 Additional specific championship penalties as set out in the Supplementary Regulations:

4.2.1 The Clerk of the Course (s) has the right to impose a Stop Go or Drive Through penalty, in accordance with Motorsport UK Regulation Q12.26

4.2.2 The Clerk of the Course or the Stewards of the Meeting, where a unfair advantage (whether inadvertently or not), may impose a Time Penalty in accordance with Motorsport UK Regulation C2.3 (Judicial).

4.3 Any competitor who is penalised under the Motorsport UK Sporting Regulations at any stage of an event may, at the Clerk of the Course's Instruction, incur the following Championship penalty: -

The event will be counted as one of the events contributing to their Championship score and they will be excluded from the event. Additionally, the competitor will forfeit a total of points equal to those obtained for a class win even if this results in a minus total of points.

4.4 Any Competitor who is penalised under the Championship Sporting Regulations at any stage of a Championship event and receives an allocation of penalty points on their race licence in accordance with Motorsport UK Regulations, will receive a Championship points deduction equal to the number of penalty points which were allocated. Should the same competitor receive penalty points at another round of the Championship then the number of Championship points deducted will be double the number of penalty points applied. If penalty points are applied at a third round, then the Championship points deducted will be triple this number, and quadrupled at the fourth occurrence of such a penalty etc. This may result in a driver receiving a negative score.

### **5. TECHNICAL REGULATIONS:**

#### **Organising Club:**

The Historic Sports Car Club Ltd, Silverstone Circuit, Silverstone, Nr. Towcester, Northants,

NN12 8TN.

#### **5.1 INTRODUCTION:**

The following Technical Regulations are set out in accordance with the Motorsport UK specified format and it should be clearly understood that if the following texts do not clearly specify that you can do it you should work on the principle that you cannot.

#### **5.2 GENERAL DESCRIPTION:**

5.2.1 The Historic F3 Championship is open to original single seater racing cars currently running to a configuration in which that individual chassis competed with between January 1<sup>st</sup> 1964 and December 31<sup>st</sup> 1970 compliant with International FIA F3 regulations for that period. This will include cars that competed in the Temporada Series which took place at Interlagos 10/1/1971, 17/1/1971, 25/1/1971 and Taruma 1/02/1971 under FIA (1964 - 1970) Formula 3 regulations.

5.2.2 All cars shall hold a valid FIA HTP or HSCC VIF; or shall in the opinion of the Championship Organisers otherwise comply with the eligibility requirement of the

1KF3HRA Regulations in force at 1st January 2022 ("1KF3HRA Regulations" **available to download from the 1KF3HRA Website [www.1kf3hra.org.uk](http://www.1kf3hra.org.uk)**)

**5.3 SAFETY REQUIREMENTS:**

Roll Over Protection System (ROPS) Article 5.13 of FIA Appendix K excluding drawing K-49 is mandatory. This article is attached to these regulations.

The following Articles of Motorsport UK Section (K) Safety Criteria Regulations will apply:

Seat Belts K2.1, K2.1.4 & Q19.14.2; Extinguishers K3.1 & K 3.1.2 a); K5, & K8 - K14.

It is recommended that; The only liquid engine coolants shall be water with the addition of Glycol based antifreeze solution if required. This is to avoid the use of oil based substances which can be dangerous if spilt on to the circuit.

**5.4 GENERAL TECHNICAL REQUIREMENTS & EXCEPTIONS:**

5.4.1 All vehicles must comply with their FIA or HSCC Identity Documents and hold, or be eligible to obtain an FIA Historic Technical Passport (HTP) (which is strongly encouraged and may be required for any championship round held outside of Great Britain and Northern Ireland); and must comply with the 1KF3HRA Regulations

5.4.2 All vehicles must have been raced in period and subject to any variation specifically permitted by the 1KF3HRA Regulations race in that specification.

5.4.3 Subject to their HSCC Identity Document indicating otherwise, vehicles must comply with vehicle regulations Section J and Q

5.4.4 Cooper T72s or T76s which have either; an original chassis number, or one that has been issued a retrospective chassis number by the Cooper Car Club, subject to the Historic Formula 3 registrar approval will be offered a HSCC VIF and will be eligible to race in Class A only, if built to class A specifications regarding wheel sizes and tyres, with a BMC or Ford side draught engine and a Jack Knight Imp or Hewland gearbox.

Engine must be compliant to section 5.7 and be either a BMC or Ford Side draught (Down draught is not permitted). Gearbox must be compliant to section 5.9 and be either a Jack Knight Imp or Hewland Mk 6.

**5.5 CHASSIS:** As the car's FIA or HSCC Identity document.

**5.6 BODYWORK:**

5.6.1.1 Modifications permitted - as the car's FIA or HSCC Identity document.

*In exception to the FIA HTP and the HSCC VIF the following is permitted; -*

*In order to reduce the engine coolant temperature, it is permitted to deviate from the HSCC Vehicle Identity Form and/or the FIA Historic Technical Passport in relation to bodywork to add additional tabs to the air exits from the radiator and also to increase to area of the intake to the radiator to improve the cooling air flow. Note any additional tabs added should be limited to 50mm protrusion from the adjacent bodywork. They may be at any angle to the general plan profile, however in side elevation they must be nominally vertical ( $\pm 15$  degree).*

5.6.1.2 Minimum ground clearance with driver in place to be 40mm.

5.6.2 Modifications Prohibited.

Aerodynamic devices are not permitted

**5.7 ENGINE:**

**5.7.1 Permitted Modifications**

As the car's FIA or HSCC Identity document.

Maximum capacity: 1000cc.

The engine shall be equipped with only one carburettor, whatever its number of chokes, and a throttling flange of a maximum diameter of 36 mm and a minimum thickness of 3 mm shall be compulsorily mounted between carburettor and inlet pipe, through this throttling flange all the carburetted mixture feeding the cylinders must pass. This shall include the period Novamotor slide throttle type where the lead in taper extends into the carburettor.

**The following clarification apply to Ford based engines only**

Roller rockers not permitted

Only single scavenge rotor oil pumps are permitted

Only 105E, 109E, 681F and 711M-6015 AA (with only three main bearings) cylinder blocks permitted

Distance between the centres of the Big end journal and the little end journal of the Connecting rods must not be greater than 4.830".

The use of Titanium valve retainers is permitted.

The minimum stroke must not be less than 48.30mm.

*From 1<sup>st</sup> January 2021 the minimum diameter of the valve stem where it slides in the valve guide must not be less than 0.2762"*

The minimum diameter of the Crank pin journal must not be less than 1.8926" or 48.072 mm. The minimum diameter of the Main bearing journal must not be less than 2.085" - 2.086" or 52.959mm - 52.984mm.

### **The following clarification applies to BMC engines**

Permitted blocks

| Stamping | Engine size                   | Part no. |
|----------|-------------------------------|----------|
| 2A799    | Early Morris Minor A35 Sprite |          |
| 12A497   | 998 thick deck pre A+ -       |          |
| AEG131   | Cooper S 970                  | 28G233   |
| AEG151   | Cooper S 1070                 | 38G321   |
| AEG312   | Cooper S 1275 thin deck       | 38G354   |

Stroke Maximum 76.2mm (2.30ins) Minimum 71.628mm (2.82ins)

Bearing journal sizes 2.000" main and 1.625" Big end. (Period standard sizes)

Maximum swept volume not to exceed 1000cc. No rebore allowance.

Cylinder head bearing the casting number 12G940 and the "Swiftune" 12G940 cylinder head, which must be marked visibly with the word "Swiftune" on their casting are permitted.

No divided central exhaust port.

Only standard ratio rockers. Roller rockers not permitted.

Side mounted oil scavenge pump permitted.

*All engines shall have provision for sealing as listed:*

*Sump: Two holes through block/sump flange, diagonally opposite. An alternative method can be two adjoining pairs of bolts or studs, again a pair each side or diagonally, cross drilled. Head: Two adjoining head bolts or studs (per head) cross drilled or such other drillings which prevents head removal e.g. Rocker cover. The hole size in all instances to be 2mm.diameter minimum.*

### **5.8 SUSPENSION** As the car's FIA or HSCC Identity document.

*Minimum Ground clearance 40mm measured with driver seated normally.*

*Dampers shall be of a type fitted in period, of aluminium or steel twin-tube construction, with no more than two way adjustment e.g. Koni 8212. Monotube gas dampers are not permitted.*

### **5.9 TRANSMISSION:**

5.9.1 As the car's FIA or HSCC Identity document. A gearbox of the same manufacturer and type as period fitment must be retained.

5.9.2 Only gearboxes with a maximum 4 forward gears and a single reverse gear are permitted. Safety centralizing shafts fitted between the drive shafts and the gearbox output shafts to maintain the drive shaft location in the event of a failure of the Rotoflex couplings are mandatory.

5.9.3 Co-Axial clutch release systems are not permitted.

5.9.4 It should be noted that in period only Ø184mm (7¼") clutches were used, therefore the minimum clutch diameter is Ø184mm (7¼").

5.9.5: Standard road going clutches can be of smaller diameter i.e. the BMC 6½ inch clutch. Road going clutches must use a standard cover and pressure plate and single drive plate.

5.9.6 It is not permissible to replace any rubber drive shaft "doughnut" drive shaft couplings (Rotoflex) with a replacement universal joint coupling of the Hardy Spicer type and a sliding splined drive shaft/yoke, unless Hardy Spicer universal coupling and sliding splines were a factory fitted standard or option e.g. Brabham BT15 and 18.

5.9.7 Constant Velocity joints are not permitted

5.9.8 It is not permitted to use a carbon ceramic clutch or other modern materials.

5.9.9 It is not permitted to use a titanium flywheel.

5.9.10 Limited slip differentials are not permitted



**5.10 ELECTRICS:** As the car's FIA or HSCC Identity document.

5.10.1 A red warning light must be fitted (K5).

5.10.2 The use of lithium-based batteries is prohibited.

**5.11 BRAKES:** As the car's FIA or HSCC Identity document.

Hydraulic pipes may be replaced by Aeroquip or similar. Cross drilled discs not permitted. Driver adjustable brake balance bars are permitted.

**5.12 WHEELS/STEERING:** As the car's FIA or HSCC Identity document.

Class A: Maximum dimensions 6.5" x 13" Minimum Rim Width Front 5" Rear 6".

Class B: Wheel Rim Maximum Dimensions Front 13" x 9" Rear 13" x 11" Minimum Rim width for Avon tyres is Front 7" Rear 9".

**5.13 TYRES.**

5.13.1 Eligible tyres are as follows:

**Class A**

Avon ACB9 moulded tread pattern A 37 Compound reference 7660 and 7661, or

Dunlop 'L' Section 204 Compound CR65 Tread Pattern

**Class B and F3 cars in Class I**

Avon A37 7342 and 7343 hand cut to CR65

All weather pattern Dunlop L or M Section 204 Compound cut to CR65 tread pattern.

For Wet Conditions: Avon Slick cut to Classic Wet Formula Pattern Reference 7714 and 7715 in A37 Compound, or Dunlop 'L' and 'M' Section CR65 204 compound or 'Post Historic' 204 compound.

Dry condition tyres can also be used under wet conditions.

**F2 cars in Class I**

*Avon A37 7342 and 7343 hand cut to CR65*

*All weather pattern Dunlop L or M Section 204 Compound cut to CR65 tread pattern.*

5.13.2 The use of tyre heating/heat retention devices, tyre treatments and compounds is prohibited

**5.14 WEIGHTS:** Weight must conform to the minimum of 400 kg without fuel.

**Note:** - The minimum weight is that of the car in running order i.e. with all lubrication and cooling liquids but without fuel.

**Class I Historic F2 cars minimum weight 420kg.** *Note if a car crosses the finish line first overall more than once per season it may be subject to an increase in minimum weight of 420kg.*

**5.15 FUEL TANK/FUEL:**

5.15.1 As the car's FIA or HSCC identity document.

5.15.2 Fuel must be in accordance with Motorsport UK regulations Section B Nomenclature & Definitions Pump Fuel parts (a) or (b),

**5.16 SILENCING:**

All vehicles must comply with Motorsport UK Regulation J5.17 i.e. 108db and are also subject to individual circuit requirements in Supplementary Regulations.

**5.17 Number & Championship Decals**

Numbers must be displayed as per Motorsport UK Yearbook Section J4 and Drawing 4. It is a competitor's responsibility for his competing vehicle to be easily identified by all course officials.

Individual sponsors decals are limited to two per vehicle dimensions and limitations as per Motorsport UK Regulation H28.1.1 - H28.1.6

All competing cars must display at least two HSCC badges one on each side of the car.

## 6. APPENDICES

### 6.1 Race Organising Club and Contacts

**HISTORIC SPORTS CAR CLUB Ltd** - Silverstone Circuit, Silverstone, Towcester, Northants,  
NN12 8TN

(T) 01327 858400 (F) 01327 858500 email: [office@hsc.org.uk](mailto:office@hsc.org.uk)

Website: [www.hsc.org.uk](http://www.hsc.org.uk)

**CHAMPIONSHIP COMMITTEE** - Please direct all correspondence through the HSCC Office.

**Chairman**

Simon Armer

**Eligibility Registrars:**

Keith Messer & David Pullen

---

## FiA Appendix K

### Appendix VI

---

All drawings referred to in these articles are in Appendix K, Appendix V

#### 1. ROLL CAGE

1.1.4 Titanium ROPS are not permitted for Historic F3 cars

Aluminium alloy ROPS are not for Historic F3 cars

#### 1.1.5 Specifications

The specification of the structure installed must be detailed on the Roll Over Protection Structure Description document which must be attached, as an appendix, to all HTPs issued after 1/1/2014.

(b) Single-seat racing cars and two-seat racing cars from Period F onwards must be fitted with a ROPS conforming to period specification (if a ROPS was required by the regulations), or to Article 1.2.5.2 of this Appendix. In either case, except for ROPS of free structural conception and certified to withstand the stress minima as per article 1.2.5.2, the tubes of the main rollbar and braces must have dimensions not less than those as per the above mentioned article, and the structure must be a minimum of 5cm above the top of the Driver's and Co-driver's helmets at all times.

Extensions added above the main structure to increase the height are forbidden unless covered by an ASN or FIA rollcage certificate.

Cars conforming entirely to a specification after 1968: the width must be at least 38cm measured inside the rollbar between the two vertical pillars of the sides. It must be measured, horizontally and parallel to the Driver's shoulders, at a distance of 60cm (following the Driver's spine) above the base of the seat's rigid shell. This dimension is recommended for cars conforming entirely to a pre 1969 specification. The year asserted on the car's HTP will be used to establish the ROPS specification required (see Drawing K-62, Appendix V).

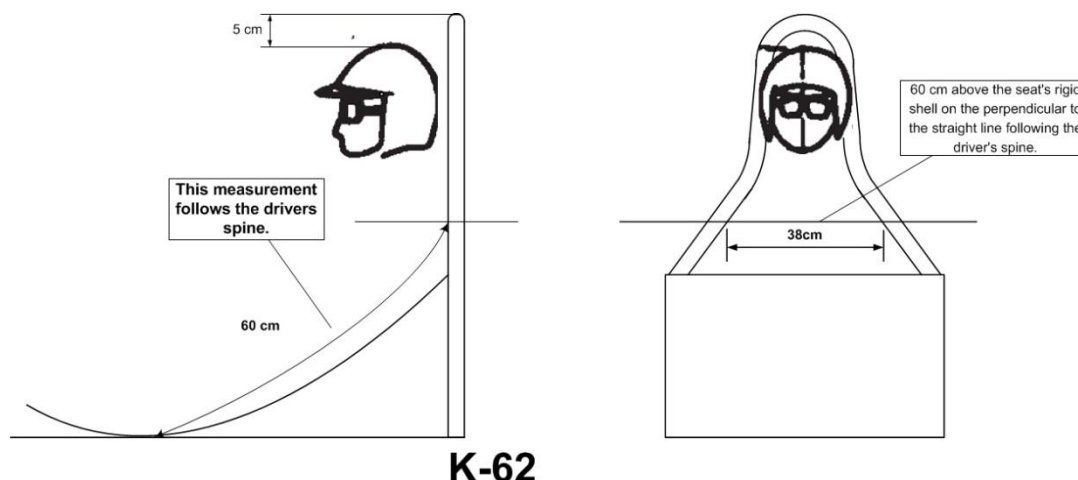

#### 1.2.3.3.4 Removable connections

Should removable connections be used in the construction of the ROPS they must comply with or be similar to a type approved by the FIA (see Drawings from K-39 to K-49). The screws and bolts must be of a sufficient minimum diameter, and of the best possible quality (minimum quality 8.8).

#### 1.2.3.3.5 Welding instructions

This must be carried out along the whole perimeter of the tube. All welding must be of the highest quality possible with full penetration (preferably arc welding and in particular heliarc). Although good outside appearance of a weld does not necessarily guarantee its quality, poor looking welds are never a sign of good workmanship.

When using heat treated steel the special instructions of the manufacturers must be followed (special electrodes, welding under protecting gas).

It must be pointed out above all else that the manufacture of heat treated steel, and high carbon steels may cause certain problems and that bad construction may result in a decrease in strength (crinkling) and an absence of flexibility

#### 1.2.4 Material Prescriptions

Only tubes with a circular section are authorised.

Specifications of the tubes used:

| Material<br><i>Matériau</i>                                                                                                                                                                                                                                      | Minimum tensile strength<br><i>Résistance minimale à la traction</i> | Minimum dimensions (mm)<br><i>Dimensions minimales (mm)</i>  |                                                               | Use<br><i>Utilisation</i>                                                                                                                                                                                                                             |
|------------------------------------------------------------------------------------------------------------------------------------------------------------------------------------------------------------------------------------------------------------------|----------------------------------------------------------------------|--------------------------------------------------------------|---------------------------------------------------------------|-------------------------------------------------------------------------------------------------------------------------------------------------------------------------------------------------------------------------------------------------------|
|                                                                                                                                                                                                                                                                  |                                                                      | Periods F-G2<br><i>Périodes F-G2</i>                         | From Period H1 onwards<br><i>A partir de Période H1</i>       |                                                                                                                                                                                                                                                       |
| Cold drawn seamless unalloyed carbon steel (see below) containing a maximum of 0.3% of carbon<br><br><i>Acier au carbone non allié (voir ci-dessous) étiré à froid sans soudure contenant au maximum 0.3 % de carbone</i>                                        | 350 N/mm <sup>2</sup>                                                | 38 x 2.5<br>(1.5"x0.095")<br>ou<br>40 x 2.0<br>(1.6"x0.083") | 45 x 2.5<br>(1.75"x0.095")<br>ou<br>50 x 2.0<br>(2.0"x0.083") | Main rollbar or Lateral rollbars according to construction<br><br><i>Arceau principal ou Arceaux latéraux selon la construction</i>                                                                                                                   |
|                                                                                                                                                                                                                                                                  |                                                                      |                                                              | 38 x 2.5<br>(1.5"x0.095")<br>ou<br>40 x 2.0<br>(1.6"x0.083")  | Lateral half-rollbars and other parts of the safety cage (unless otherwise indicated in the articles above)<br><br><i>Demi-arceaux latéraux et autres parties de l'armature de sécurité (sauf indications contraires dans les articles ci-dessus)</i> |
| Cars of Period H1 onwards issued with an HTP before 1/1/2010 may use minimum dimensions for Periods F-G2.<br><i>Les voitures à partir de la Période H1 dont le PTH a été délivré avant le 1/1/2010 peuvent avoir les dimensions minimales des Périodes F-G2.</i> |                                                                      |                                                              |                                                               |                                                                                                                                                                                                                                                       |

These dimensions represent the minimum allowed. Only steel is authorised. In choosing the quality of the steel, attention must be paid to the elongation properties and the weldability. Note: For an unalloyed steel, the maximum content of additives is 1.7% for manganese and 0.6% for other elements.

The tubing must be bent by a cold working process and the centreline bend radius must be at least three times the tube diameter.

If the tubing is ovalised during bending, the ratio of minor to major diameter must be 0.9 or greater.

The surface at the level of the bends must be smooth and even, without ripples or cracks. Any coating (i.e. chrome) of the tubes is forbidden, except painting.

1.2.5.2 Single seater and two seater racing cars – Strength In order to obtain a sufficient strength for the rollbar, two possibilities are left to the manufacturers:

a) The ROPS, of entirely free structural conception, must be capable to withstand the stress minima indicated as follows:

- 1.5 w lateral,
- 5.5 w fore and aft,
- 7.5 w vertical,

With w being 740kg.

b) The tubes and brace(s) must have a diameter of at least 1 3/8 inch (3.5cm) and at least 0.090 inch (2mm) wall thickness. Where option a) is used, a certificate to substantiate the strength of the ROPS must be presented. The material should be molybdenum chromium SAE 4130 or SAE 4125 (or equivalent in DIN, NF, etc.) or cold drawn low carbon seamless steel tube.

There must be at least one brace from the top of the bar rearwards at an angle not exceeding 60° to the horizontal fixed to the structure of the car.

The diameter and material of the brace must be the same as those of the rollbar itself.  
 In the case of two braces, the diameter of each of them may be reduced to 26/20 (ext. / int.) mm.

Removable connection between the main hoop and the brace must comply with Drawings K-39 to K-49.

Forward fitted stays are allowed only if used in period or a rearward stay is not possible.

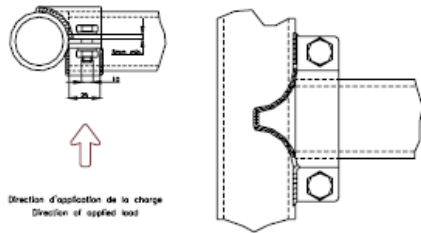

K-39

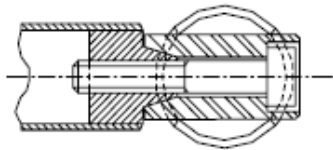

K-40

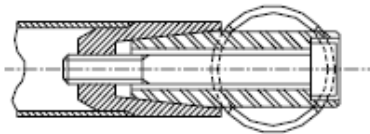

K-41

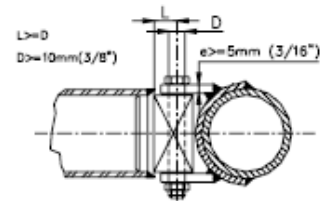

K-42

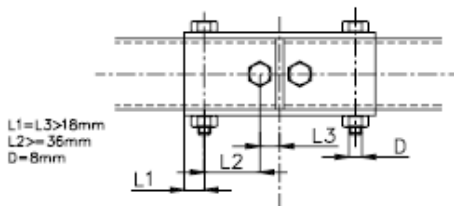

K-43

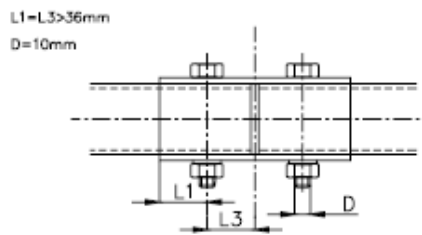

K-44

L doit être minimum  
 La largeur de la patte doit  
 être d'au moins 25mm

L must be minimum  
 The clamp width must  
 be at least 25mm

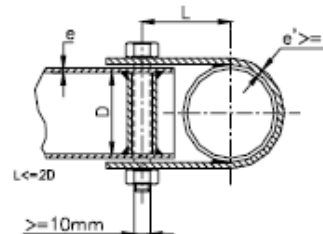

K-45

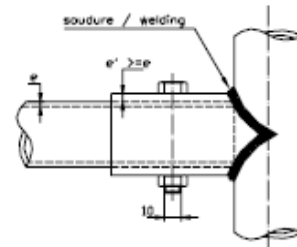
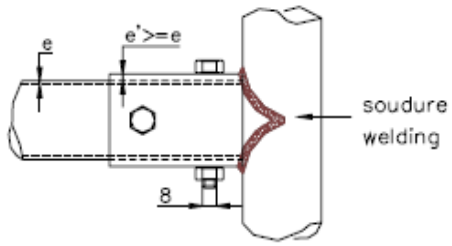

Dessin / Drawing N° 253-35

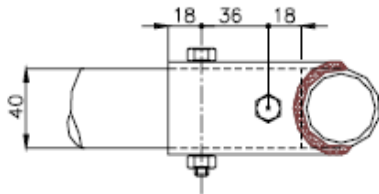

K-46

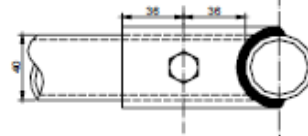

K-47

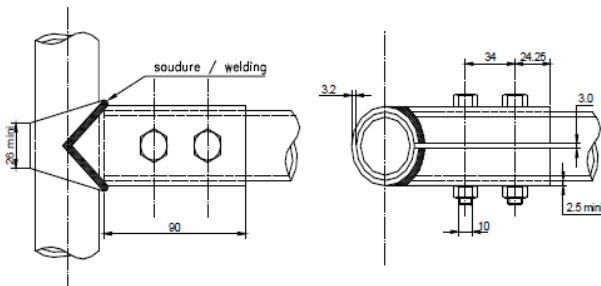

K-48

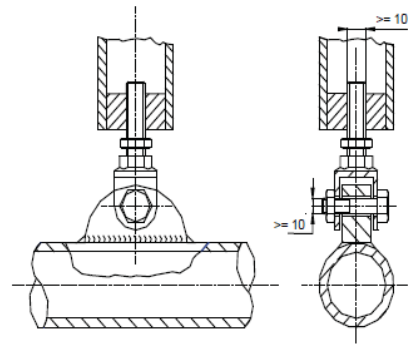

K-49